



Zeskanttegel

Dé tegel voor zware belasting

De zeskanttegel van De Hamer is speciaal ontwikkeld voor verharding die zwaar wordt belast. Je kunt ze bijvoorbeeld toepassen bij loskaden, haven-, bedrijfs- en industrieterreinen. De zeskanttegel heeft een facet van 2 mm en is leverbaar in alle gangbare uitwassingen en kleuren. De tegels worden duurzaam circulair geproduceerd; standaard worden er secundaire grondstoffen in het onderbeton verwerkt. De zeskanttegel is leverbaar in machinaal pakket met verspringend verband 5-5-5.



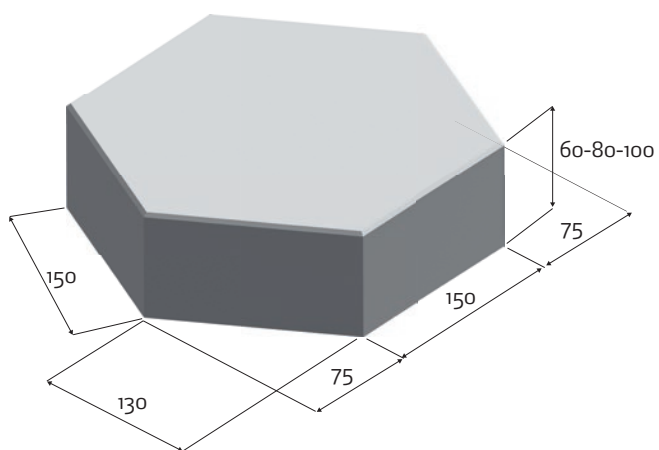
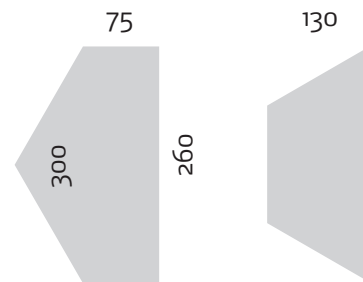
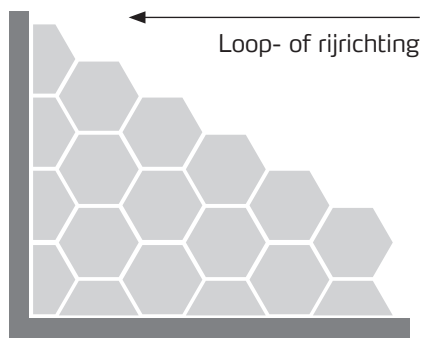

Uitgewassen zeskanttegel



Afmetingen en gewichten

Afmeting	Stuks per pallet	Aantal m ² per pallet	Gewicht per pallet
300x260x60 mm	180 stuks	10,65 m ² , 12 lagen	1535 kg
300x260x80 mm	150 stuks	8,87 m ² , 10 lagen	1705 kg
300x260x100 mm	120 stuks	7,10 m ² , 8 lagen	1705 kg
4-zijdig 60 mm	150 stuks	4,4 m ²	485 kg
4-zijdig 80 mm	150 stuks	4,4 m ²	645 kg
4-zijdig 100 mm	150 stuks	4,4 m ²	1077 kg
5-zijdig 60 mm	150 stuks	4,4 m ²	565 kg
5-zijdig 80 mm	150 stuks	4,4 m ²	750 kg
5-zijdig 100 mm	150 stuks	4,4 m ²	1125 kg

Kleuren

De zeskanttegels zijn in verschillende varianten verkrijgbaar. Hieronder is een selectie van de kleuren weergegeven. Ook is het mogelijk om op aanvraag een eigen kleur te ontwerpen.

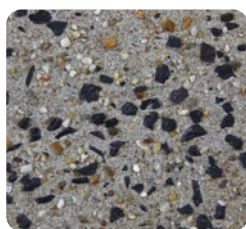

W1101

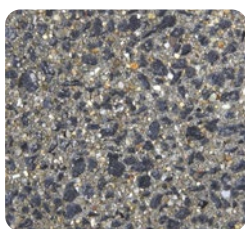

W1102

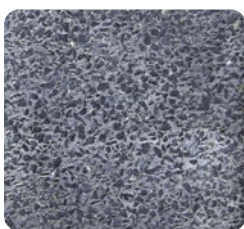

W1103

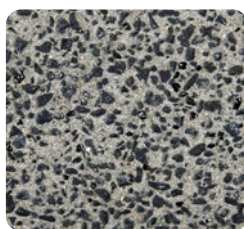

W1106

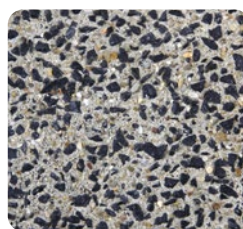

W1108



W1109

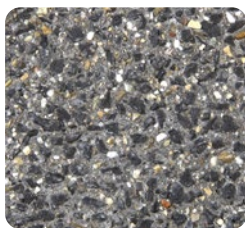

W1127



W1307

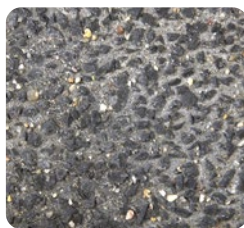

W1901



W2104



W3202

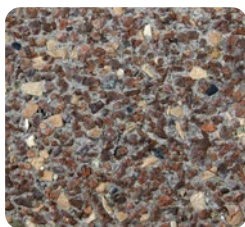

W3204



W3489

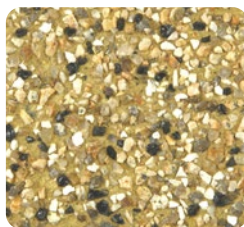

W3503

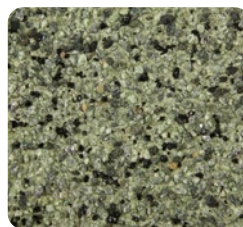

W3504



W3505



W3506



W4508



W5301



W5303



Eigen ontwerp



Prefab betonleverancier riolering en bestrating

De Hamer Beton B.V.

Weezenhof 9307, 6536 AE Nijmegen
Postbus 11, 6669 ZG Dodewaard

T +31 (0)24 344 1244

E info@dehamer.nl

www.dehamer.nl

onderdeel van



BTE GROEP